

**Bissell®**



STAINPRO 10

1456 SERIES

# IMPORTANT SAFETY INSTRUCTIONS

## READ ALL INSTRUCTIONS BEFORE USING YOUR DEEP CLEANER.

When using an electrical appliance, basic precautions should be observed, including the following.

### **WARNING** TO REDUCE THE RISK OF FIRE, ELECTRIC SHOCK, OR INJURY:

- » Unplug from electrical socket when not in use and before cleaning, maintaining or servicing the appliance.
- » This appliance can be used by children aged from 8 years and above and persons with reduced physical, sensory or mental capabilities or lack of experience and knowledge if they have been given supervision or instruction concerning use of the appliance in a safe way and understand the hazards involved. Cleaning and user maintenance shall not be made by children without supervision.
- » Children should be supervised to ensure that they do not play with the appliance.
- » If the supply cable is damaged, it must be replaced by the manufacturer, its service agent or similarly qualified persons in order to avoid a hazard.
- » Do not run appliance over cable.
- » Keep hair, loose clothing, fingers, and all parts of body away from openings and moving parts of the appliance and its accessories.
- » Use only the type and amount of liquids specified under the Operations section of this guide.
- » Do not leave appliance when plugged in.
- » Always connect to a properly earthed electrical socket. Do not modify earthed plug.
- » Use indoors only.
- » Do not allow to be used as a toy.
- » Use only as described in the user guide.
- » Use only manufacturer's recommended attachments.
- » Do not use with damaged cable or plug.
- » Do not immerse in water or liquid.

- » If appliance is not working as it should, has been dropped, damaged, left outdoors, or dropped into water; do not attempt to operate it and have it repaired at an authorized service center.
- » Liquid or steam must not be directed towards equipment containing electrical components.
- » Do not pull or carry by cable, use cable as a handle, close door on cable, or pull cable around sharp edges or corners.
- » Keep cable away from heated surfaces.
- » Do not unplug by pulling on cable.
- » To unplug, grasp the plug, not the cable.
- » Do not handle plug or appliance with wet hands.
- » Do not put any object into openings.
- » Do not use with any opening blocked; keep free of dust, lint, hair, and anything that may reduce air flow.
- » Turn off all controls before unplugging.
- » Use extra care when cleaning on stairs.
- » Do not use to pick up flammable or combustible liquids, such as petrol, or use in areas where they may be present.
- » Do not pick up toxic material (chlorine bleach, ammonia, drain cleaner, etc.)
- » Do not use appliance in an enclosed space filled with vapors given off by oil base paint, some mothproofing substances, flammable dust, or other explosive or toxic vapors.
- » Do not pick up hard or sharp objects such as glass, nails, screws, coins, etc.
- » Keep appliance on a level surface.
- » Do not carry appliance while in use.
- » Unplug before attaching the TurboBrush™ tool.
- » If your appliance is fitted with a nonrewireable BS 1363 plug it must not be used unless a 13 amp (ASTA approved to BS 1362) fuse is fitted in the carrier contained in the plug. Spares may be obtained from your BISSELL supplier. If for any reason the plug is cut off, it must be disposed of, as it is an electric shock hazard should it be inserted into a 13 amp socket.

 **WARNING**  
TO REDUCE THE RISK OF FIRE AND ELECTRIC SHOCK, USE INDOORS ONLY . DO NOT IMMERSE. USE ONLY ON SURFACES MOISTENED BY THE CLEANING PROCESS. USE ONLY BISSELL CLEANING PRODUCTS INTENDED FOR USE WITH THIS MACHINE.

 **WARNING**  
TO REDUCE THE RISK OF FIRE AND ELECTRIC SHOCK, ALWAYS INSTALL FLOAT BEFORE ANY WET PICK-UP OPERATION.

## SAVE THESE INSTRUCTIONS

**FOR OPERATION ON A 220-240 VOLT A.C. 50-60 HZ POWER SUPPLY ONLY.**

This model is for household use only.

# Thanks for buying a BISSELL deep cleaner

We're glad you purchased a BISSELL deep cleaner. Everything we know about floor care went into the design and construction of this complete, high-tech home cleaning system.

Your BISSELL deep cleaner is well made, and we back it with a limited five-year guarantee. We also stand behind it with a knowledgeable, dedicated Consumer Care department, so, should you ever have a problem, you'll receive fast, considerate assistance.

My great-grandfather invented the floor sweeper in 1876. Today, BISSELL is a global leader in the design, manufacture, and service of high quality homecare products like your BISSELL deep cleaner.

Thanks again, from all of us at BISSELL.

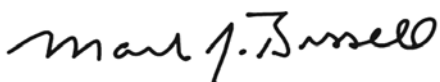





Mark J. Bissell  
Chairman & CEO

Safety Instructions . . . . .	2
Product View . . . . .	4
Assembly . . . . .	5
Operations . . . . .	6-10
Maintenance & Care . . . . .	11-13
Troubleshooting . . . . .	14
Guarantee . . . . .	16
Consumer Care . . . . .	16

## TIPS

- » Deep cleaning carpeting regularly can reduce dust and allergens in your home.
- » Deep cleaning stairs and high-traffic areas on a regular basis helps prolong carpet life.

	<b>WARNING</b>	<b>AN ACTION OR ATTENTION IS NEEDED TO THIS AREA IN ORDER TO REDUCE THE RISK OF ELECTRIC SHOCK, FIRE, OR INJURY</b>
	<b>GUIDE</b>	<b>READ USER GUIDE FOR COMPLETE SAFETY AND USER INSTRUCTIONS</b>
 	<b>WEEE</b>	<b>DO NOT THROW THE APPLIANCE AWAY WITH THE NORMAL HOUSEHOLD WASTE AT THE END OF ITS LIFE, BUT HAND IT IN AT AN OFFICIAL COLLECTION POINT FOR RECYCLING. BY DOING THIS YOU WILL HELP TO PRESERVE THE ENVIRONMENT.</b>

# Product View

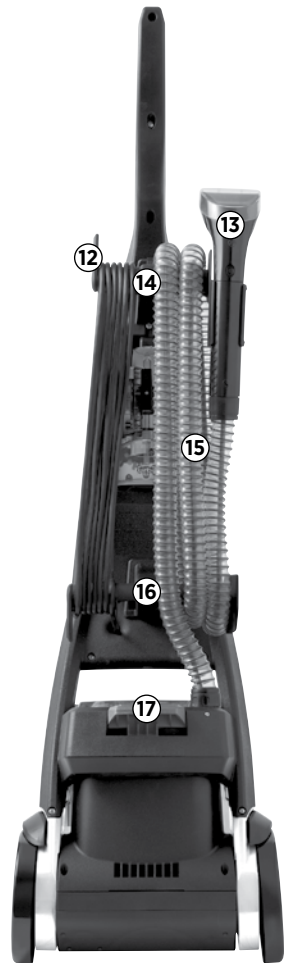

- 1 Spray Trigger
- 2 Cord Clip
- 3 Upper Handle
- 4 Power Cord
- 5 Power Button
- 6 Carry Handle
- 7 Tank Carry Handle
- 8 2-in-1 Water Tank
- 9 Tank Latch

- 10 Removable Nozzle
- 11 EdgeSweep™ Brushes
- 12 Quick Release™ Cord Wrap
- 13 Cleaning Tool (tools vary by model)
- 14 Upper Hose/Cord Rack
- 15 Hose
- 16 Lower Hose/Cord Rack
- 17 Recline Pedal

# Assembly

Your deep cleaner comes in four easy-to-assemble components:

- Upper Handle with Screws**
- Lower Base**
- Upper Hose Rack**
- Upper Tool Holder**

The only thing you will need to assemble your cleaner is a Phillips head screwdriver.

- 1.** Side upper handle onto lower base and secure by screwing 2 screws into marked holes on back of lower base (screws will be taped to the handle grip).
- 2.** Place upper hose/cord rack onto back side of upper handle and secure by screwing 1 screw into hole at bottom of rack.
- 3.** Wrap hose around lower and upper hose/cord racks and secure it by inserting trigger on hose grip into opening on hose grip holder located on upper hose/cord rack.

**NOTE: Make sure to wrap hose beginning from back of bottom hose/cord rack and then wrapping over and around top of upper hose/cord rack.**

- 4.** Wrap cord around lower and upper hose/cord racks and secure plug to cord with clip on plug.
- 5.** Attach cleaning tools as necessary to storage locations on bottom hose/cord wrap and end of hose grip.

Deep cleaner assembly is now complete.

## **WARNING**

Do not plug in your deep cleaner until you are familiar with all instructions and operating procedures.

**1.**

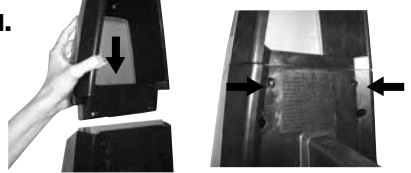

**2.**

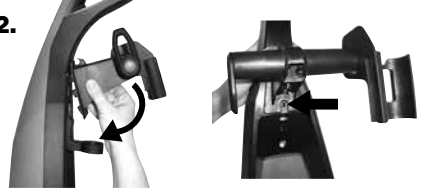

**3.**



# Operations

## Cleaning fluid

Keep plenty of genuine BISSELL 2X\* formula on hand so you can clean whenever it fits your schedule. Always use genuine BISSELL deep cleaning formulas. Non-BISSELL cleaning solutions may harm the machine and may void the guarantee.

## **WARNING**

To reduce the risk of fire and electric shock due to internal component damage, use only BISSELL cleaning fluids intended for use with the deep cleaner.



1.5 L 2X\* Wash & Protect PRO Professional Stain & Odour Formula w/ Scotchgard™ Protector  
**#1089E**



1.5 L 2X\* Wash & Protect PET Pet Stain & Odour Formula w/ Scotchgard™ Protector  
**#1087E**



1.5 L 2X\* Wash & Protect Stain & Odour Formula w/ Scotchgard™ Protector  
**#1086E**



1.5 L 2X\* Wash & Remove OXY Deep Clean + Oxy Formula  
**#1265E**



1.5 L 2X\* Wash & Refresh Blossom & Breeze Fragrance Formula w/ Febreze® Freshness  
**#1078E**



1.5 L 2X\* Wash & Refresh Cotton Fresh Formula w/ Febreze® Freshness  
**#1079E**



1.5 L 2X\* Wash & Refresh Natural Orange Formula  
**#1146E**



650 mL Stain Pretreat  
**#1147E**

\*2X concentrated formula, 60 mL is equivalent to 120 mL of non-concentrated formula.

## Special features

### Heatwave Technology™

This deep cleaner features Heatwave Technology that helps maintain the temperature of the hand hot tap water you put in it to provide constant heat as you clean. The Heatwave Technology automatically turns on when you turn the machine on.

### Scotchgard™ Protector

Carpet protection applied at the mill typically wears down over time from heavy foot traffic and everyday cleaning, including deep cleaning. To help restore this important protection, only BISSELL offers deep cleaning formulas with Scotchgard protector. This offers extra protection against dirt and tough stains to keep your carpets looking good longer.



# Operations

## Before you clean

1. Plan activities to give your carpet time to dry.
2. Move furniture to another area if cleaning an entire room (optional).
3. Vacuum area with a dry vacuum cleaner thoroughly before deep cleaning.
4. Plan your cleaning route to leave an exit path. It is best to begin cleaning in the corner farthest from your exit.
5. Pretreating (optional):

Pretreating is recommended to improve cleaning effectiveness for heavily soiled carpet in high traffic areas such as entryway and hallways.

### To pretreat:

- a. Using BISSELL Stain Pretreat (sold separately), generously spray evenly over soiled area. **Do not overwet.**
- b. Wait 3-5 minutes before deep cleaning.
- c. Clean as normal using your BISSELL deep cleaner, following instructions below.

## WARNING

To reduce the risk of fire and electric shock due to internal component damage, use only BISSELL cleaning fluids intended for use with the deep cleaner. Non-BISSELL cleaning solutions may harm the machine and may void the guarantee.

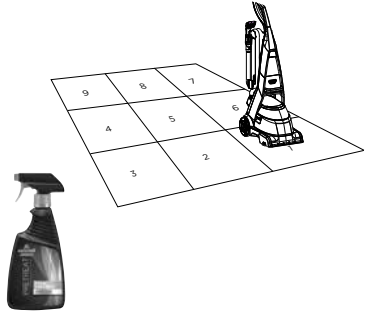

## Filling the 2-in-1 water tank

1. Remove tank from base of machine by lifting up tank carry handle. Carry like a bucket to the sink.
2. Unlatch top of tank from bottom by lifting up on tank latches on each side of the tank.
3. Fill bladder with hand hot (60°C/140°F MAX) tap water. **Do not boil or microwave water as it can destroy the bladder.**
4. Using measuring cup provided, pour two measuring cups filled to the indicated line on measuring cup (5 oz/138 ml total) into bladder.

**NOTE: Always use genuine BISSELL 2X formulas to maximize cleaning and for the safety of your machine.**

5. Replace top of tank back onto bottom and secure latches on both sides of tank.

**NOTE: Remember to secure tank latches on each side of tank and test to make sure they are secure before picking up tank.**

6. Place tank back into machine base, seating firmly in place.

1.



2.



4.



5.

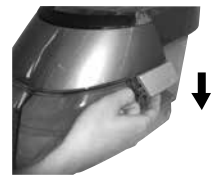

# Operations

## Carpet cleaning

1. Plug into a proper outlet and push power button ① located on front of handle.
2. Recline handle by pressing on recline pedal on back of machine behind 2-in-1 water tank.
3. While pressing spray trigger, make one slow forward wet pass and another one back.

**Caution: Do not overwet.**

**NOTE: Your machine is equipped with a circuit breaker that will automatically shut off the brush if a large or loose object is caught in the brush roll. If that happens, be sure to unplug your machine, remove the foreign object, and then plug machine back in to reset circuit breaker.**

4. Release spray trigger and make one slow forward and backward pass over same area.
5. Repeat cleaning passes until solution being suctioned up appears clean. Continue passes without pressing spray trigger until you can't see any more water being suctioned up. Repeated passes will help aid in dry time.

**NOTE: You may notice hair and debris deposits on the carpet or in the tank that were loosened by the cleaning action. This debris should be picked up and thrown away.**

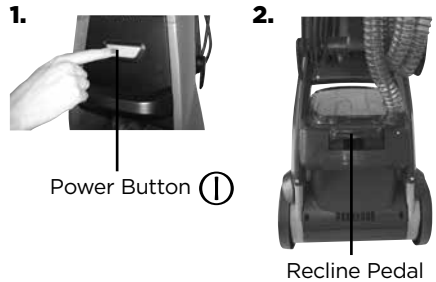

### **CAUTION**

Brushes may unexpectedly restart. To reduce the risk of injury from moving parts, unplug before removing nozzle for cleaning or servicing.

### **ATTENTION**

Some Berber carpets have a tendency to fuzz with wear. Repeated strokes in the same area with an ordinary vacuum or deep cleaner may aggravate this condition.



# Operations

## Empty the 2-in-1 water tank

1. Push power button ① off. Remove 2-in-1 water tank from base of machine by lifting up on tank carry handle. Carry like a bucket to a utility sink or outside where you will dispose of the dirty water.
2. Unlatch top of tank from bottom by lifting up on tank latches on each side of tank.
3. Remove top of tank by lifting up on handle.
4. Empty dirty water from back corner of tank.
5. After each use, remove any debris on red filter near air duct on back of base of machine while the tank is still removed.
6. To continue carpet cleaning, refer back to "Carpet cleaning" instructions on page 8.

If cleaning is complete, refer to "Maintenance and care" section starting on page 11.

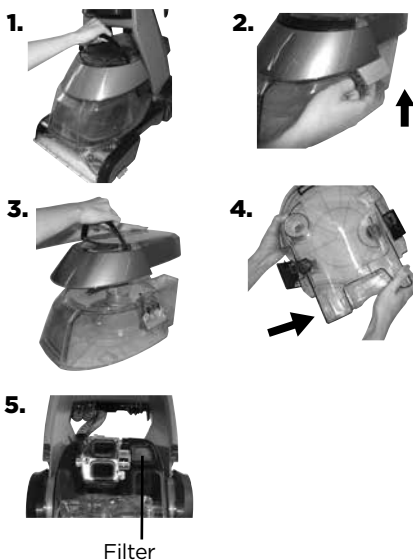

## Cleaning with attachments

Your deep cleaner comes equipped with a hose and at least one attachment for cleaning stairs, upholstery, and more.

**Important! If using to clean upholstery, check upholstery tags.**

1. Check manufacturer's tag before cleaning. "W" or "WS" on tag means you can use your deep cleaner. If the tag is coded with an "X" or an "S" (with a diagonal stripe through it), or says "Dry Clean Only", do not proceed with any deep cleaning machine. Do not use on velvet or silk. If manufacturer's tag is missing or not coded, check with your furniture dealer.
2. To begin cleaning with attachments, follow instructions on page 7 for filling 2-in-1 water tank.
3. The ProHeat 2X Professional is designed with an automatic diverter. Simply place unit in the upright position in order to clean with hose.
4. Attach cleaning tool of your choice to the end of hose.



## IMPORTANT

Check for colourfastness in an inconspicuous place. If possible, check upholstery stuffing. Coloured stuffing may bleed through fabric when it becomes wet.

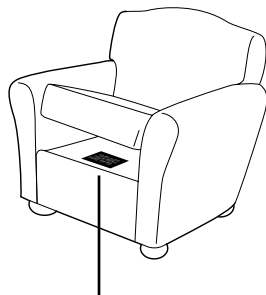

Manufacturer's tag

# Operations

## Cleaning with attachments continued

---

5. Hold tool approximately 2.5 cm above soiled surface. Press spray trigger to apply cleaning solution to soiled area. Using brush on tool, gently scrub area to be cleaned. Release spray trigger, apply downward pressure on tool and pull it toward you to suction up dirt and cleaning solution. Continue until no more dirt can be removed. **Caution: Do not overwet.**

6. When finished cleaning, remove and rinse tool(s) in clean, running water.

7. It is recommended that you suction clean water from the tap to rinse out the hose. Be careful not to over-fill your tank.

8. Before wrapping hose onto rack, lift end of hose and stretch out to ensure all water is cleared from hose.

9. Wrap hose around rack.



# Maintenance & Care

## Machine care

For best results, a few simple steps can assure your machine is well maintained after your cleaning is complete.

1. Flush your machine of any remaining residual solution.
  - a. Fill 2-in-1 water tank with clean hand hot (60°C/140°F MAX) tap water.
  - b. Recline handle and press spray trigger for 15 seconds while making forward and backward passes on carpet. Release spray trigger and make forward and backward passes for another 15 seconds or until there is no more water being suctioned up from the carpet.
2. Press power button ① off. Unplug machine and wrap power cord.
3. After emptying 2-in-1 water tank, rinse top half of tank through nozzle area. Rinse bottom half of tank with running hand hot (60°C/140°F MAX) tap water, taking care to clean underneath and around heavy duty bladder. Be sure to also empty and rinse hair and debris basket inside tank.
4. Remove any debris on red filter near air duct on back of base of machine.
5. Keeping 2-in-1 water tank off base of machine, remove nozzle by turning locking keys to “unlock” position and lifting up. Rinse nozzle in clean, running water.
6. Any loose hair or debris can be pulled from brush rolls and thrown away. For the most thorough clean before storage, follow directions on pages 12 and 13 for removal and replacement of belts and brush rolls.
7. Replace nozzle by lining up locking keys with their slots and placing nozzle back onto foot of machine. Secure into place by turning locking keys clockwise to “lock” position.
8. To clean suction diverter, remove two screws on back of diverter housing. Take diverter housing to sink and rinse with clean, running water. Take care to remove any debris that may build up and cause a clog. Replace diverter housing and two screws.
9. To clean attachments, remove from hose and rinse under clean, running water. Dry before storing. Clean hose by suctioning clean water from tap (taking care not to let tank overflow). Before wrapping back onto machine, lift end of hose and stretch out to ensure all water is cleared from hose. Refer to page 10, illustrations 7 and 8.
10. Wipe machine's exterior with a soft cloth.
11. After carpet is dry, you may wish to vacuum again to remove any leftover hair and fuzz the deep cleaner may have brought to the carpet surface.

## ⚠ WARNING

To reduce the risk of electric shock, push power button ① off and disconnect plug from electrical outlet before performing maintenance or troubleshooting checks.

## Tip

» Let all parts dry completely before storing

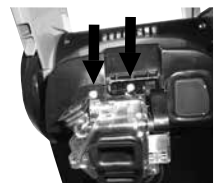

# Maintenance & Care

## Machine storage

Put unit away in a closet or basement for next use. Store cleaner in a protected, dry area. Since this product uses water, it must not be stored where there is a danger of freezing. Freezing will damage internal components and void guarantee.

## **⚠️ WARNING**

To reduce the risk of electric shock, push power button  
Ⓜ off and disconnect plug from electrical outlet before performing maintenance or troubleshooting checks.

## Fluid Connection Point Filter Maintenance

Periodic cleaning of fluid connection point filters in spray nozzle may be required.

1. To clean fluid connection point filters, remove nozzle and turn it over.
2. Clean filters on ends of fluid connection points with a small paperclip and re-attach nozzle to machine.

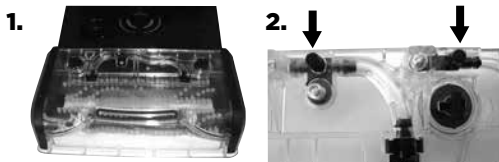

## Drive belt removal & replacement

Occasional replacement of one or both belts may become necessary. If needed, please follow instructions below.

1. Turn off machine, and unplug it from outlet. Wrap hose and cord on racks.
2. Remove 2-in-1 water tank and set aside.
3. Remove nozzle by turning locking keys counterclockwise to "unlock" position and lifting nozzle up and away.
4. Turn machine on its side. **Important: Make sure corded side is facing up.**
5. Remove 1 silver screw from pivot arm.
6. Remove pivot arm by gently lifting up.
7. Remove old drive belt and replace it with a new belt by first attaching it to small drive wheel, then attaching it to end of inside brush.
8. Place pivot arm back on and secure in place using silver screw.
9. Replace nozzle by lining up locking keys with their slots and placing nozzle back onto foot of machine. Secure into place by turning locking keys clockwise to "lock" position.

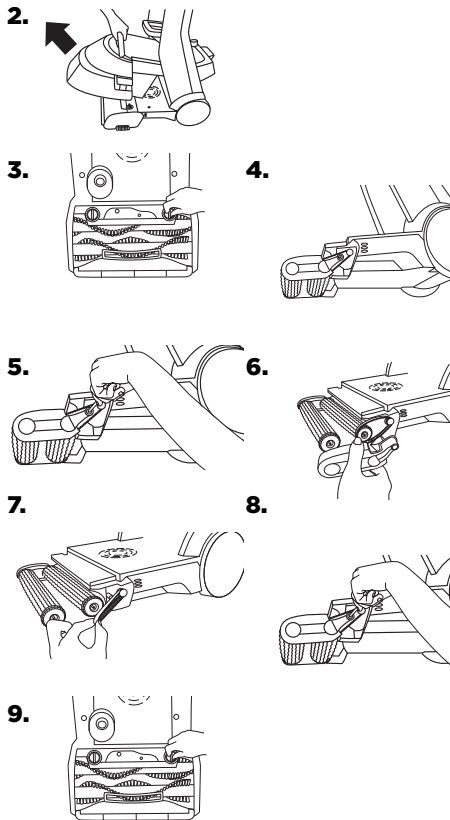

# Maintenance & Care

## Brush removal and brush belt replacement

The brushes and brush belt can be removed for cleaning or replacement as needed.

1. Turn off machine and unplug it from outlet.
2. Remove 2-in-1 water tank and set aside.
3. Remove nozzle by turning locking keys counterclockwise to “unlock” position and lifting nozzle up and away.
4. Turn machine on its side. **Important: Make sure corded side is facing up.**
5. Remove 1 silver screw from pivot arm.
6. Remove pivot arm by gently lifting up and set aside.
7. Remove drive belt. If worn or damaged, replace with new drive belt.
8. Remove brush rolls by pulling them off metal rods. Be careful not to lose small washer at each end of brush rolls.
9. Remove brush belt from the end of brush and set aside. If worn or damaged, replace with new brush belt.
10. Place cleaned or new brush rolls back onto metal rods. Make sure one washer is on each of brush rolls prior to sliding onto metal rods. Be sure metal rods slide through bushings to ensure proper fit.
11. Re-attach brush belt on bottom of cogs of small roller brushes.
12. Re-attach drive belt by first attaching it to small drive wheel, then attach it to end of inside brush.
13. Place pivot arm back on and secure in place using silver screw.
14. Replace nozzle by lining up locking keys with their slots and placing nozzle back onto foot of machine. Secure into place by turning locking keys clockwise to “lock” position.

If you have any questions or are having trouble installing or replacing your belt(s) or brushes, please call BISSELL Consumer Care.

## **WARNING**

To reduce the risk of electric shock, push power button  off and disconnect plug from electrical outlet before performing maintenance or troubleshooting checks.

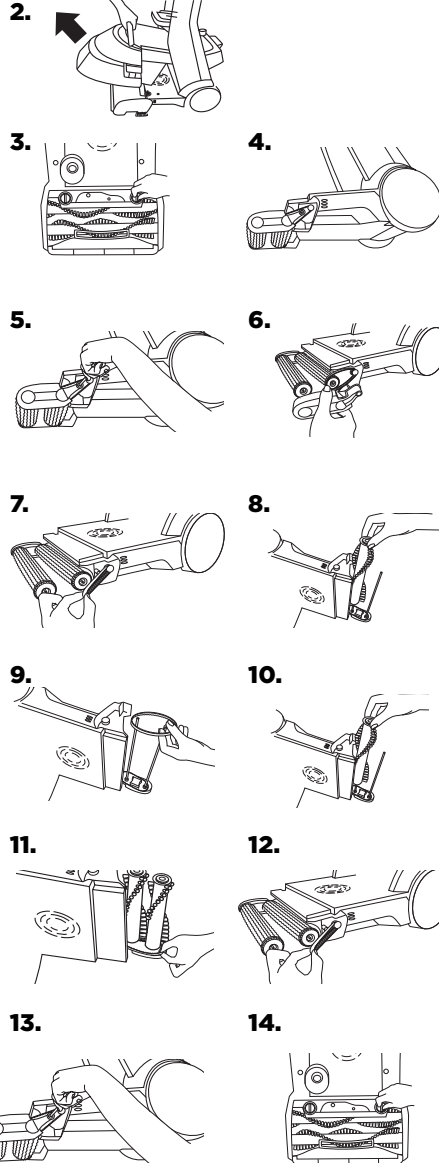

# Troubleshooting

## **⚠ WARNING**

To reduce the risk of electric shock, push power button ① off and disconnect plug from electrical outlet before performing maintenance or troubleshooting checks.

<b>Problem</b>	<b>Possible causes</b>	<b>Remedies</b>
<b>Reduced spray or no spray</b>	Bladder may be empty	Press power button ① off; refill bladder with clean hand hot (60°F/140°C MAX) tap water and formula.
	2-in-1 tank may not be seated properly	Press power button ① off; remove and reseal tank so it sits snugly on machine.
	Pump may have lost prime.	Press power button ① off; after 1 minute turn on and depress spray trigger.
<b>DirtLifter PowerBrush does not turn</b>	Belts are off or broken	Press power button ① off and unplug unit from outlet. Follow instructions on pages 12 and 13.
	Circuit breaker on machine may have tripped	Press power button ① off and unplug from outlet. Check to see if foreign object is caught in brush roll. Remove object. Plug machine in to reset circuit breaker.
<b>Cleaner not picking up solution</b>	2-in-1 tank may not be seated properly	Press power button ① off; remove and reseal tank so it sits snugly on machine.
	2-in-1 tank may not be assembled properly	Make sure tank latches on both sides of tank are latched properly.
	2-in-1 water tank has picked up maximum dirty water and red float door has closed.	Empty 2-in-1 tank and refill, refer to the Operation section.
	Red float "door" in tank may have closed as a result of bumping object or moving machine back and forth too quickly	Press power button ① off, allowing red float door to release back into open position. Press power button ① back on to continue cleaning. Be sure your forward and backward strokes are done at a slower pace.
	Red lint screen near air duct is dirty	Follow cleaning instructions in step 4 on page 11.

**Please do not return this product to the store.**

Other maintenance or service not included in the manual should be performed by an authorized service representative.

Thank you for selecting a BISSELL product.

# Notes

# Consumer Guarantee

This Guarantee only applies outside of the USA and Canada. It is provided by BISSELL International Trading Company BV ("BISSELL").

This Guarantee is provided by BISSELL. It gives you specific rights. It is offered as an additional benefit to your rights under law. You also have other rights under law which may vary from country to country. You can find out about your legal rights and remedies by contacting your local consumer advice service. Nothing in this Guarantee will replace or lessen any of your legal rights or remedies. If you need additional instruction regarding this Guarantee or have questions regarding what it may cover, please contact BISSELL Consumer Care or contact your local distributor.

This Guarantee is given to the original purchaser of the product from new and is not transferable. You must be able to evidence the date of purchase in order to claim under this Guarantee.

## Limited 5 Year Guarantee from the date of purchase by original purchaser

Subject to the \*EXCEPTIONS AND EXCLUSIONS identified below, BISSELL will repair or replace (with new or remanufactured components or products), at BISSELL's option, free of charge, any defective or malfunctioning part or product.

BISSELL recommends that the original packaging and evidence of the date of purchase be kept for the duration of the Guarantee period in case the need arises within the period to claim on the Guarantee. Keeping the original packaging will assist with any necessary re-packaging and transportation but is not a condition of the Guarantee.

If for your product is replaced by BISSELL under this Guarantee, the new item will benefit from the remainder of the term of this Guarantee (calculated from the date of the original purchase). The period of this Guarantee shall not be extended whether or not your product is repaired or replaced.

### \*EXCEPTIONS AND EXCLUSIONS FROM THE TERMS OF THE GUARANTEE

This Guarantee applies to products used for personal domestic use and not commercial or hire purposes. Consumable components such as filters, belts and mop pads, which must be replaced or serviced by the user from time to time, are not covered by this Guarantee.

This Guarantee does not apply to any defect arising from fair wear and tear. Damage or malfunction caused by the user or any third party whether as a result of accident, negligence, abuse, neglect, or any other use not in accordance with the User Guide is not covered by this Guarantee.

An unauthorised repair (or attempted repair) may void this Guarantee whether or not damage has been caused by that repair/attempt.

Removing or tampering with the Product Rating Label on the product or rendering it illegible will void this Guarantee.

SAVE AS SET OUT BELOW BISSELL AND ITS DISTRIBUTORS ARE NOT LIABLE FOR ANY LOSS OR DAMAGE THAT IS NOT FORESEEABLE OR FOR INCIDENTAL OR CONSEQUENTIAL DAMAGES OF ANY NATURE ASSOCIATED WITH THE USE OF THIS PRODUCT INCLUDING WITHOUT LIMITATION LOSS OF PROFIT, LOSS OF BUSINESS, BUSINESS INTERRUPTION, LOSS OF OPPORTUNITY, DISTRESS, INCONVENIENCE OR DISAPPOINTMENT. SAVE AS SET OUT BELOW BISSELL'S LIABILITY WILL NOT EXCEED THE PURCHASE PRICE OF THE PRODUCT.

BISSELL DOES NOT EXCLUDE OR LIMIT IN ANY WAY ITS LIABILITY FOR (A) DEATH OR PERSONAL INJURY CAUSED BY OUR NEGLIGENCE OR THE NEGLIGENCE OF OUR EMPLOYEES, AGENTS OR SUBCONTRACTORS; (B) FRAUD OR FRAUDULENT MISREPRESENTATION; (C) OR FOR ANY OTHER MATTER WHICH CANNOT BE EXCLUDED OR LIMITED UNDER LAW.

## Consumer Care

If your BISSELL product should require service or to claim under our limited guarantee, please contact us as follows:

### Website:

[www.BISSELL.com](http://www.BISSELL.com)

### Email:

[UKSupport@bissell.com](mailto:UKSupport@bissell.com)

### Telephone:

0344-888-6644

### Write:

BISSELL Homecare (Overseas) Inc.  
Ground Floor  
226 Berwick Avenue  
Slough, Berkshire, SL1 4QT  
United Kingdom

Spares are available for purchase.

To purchase visit [www.4bissell.co.uk](http://www.4bissell.co.uk)

## Visit the BISSELL website: [www.BISSELL.com](http://www.BISSELL.com)

When contacting BISSELL, have model number of cleaner available.

Please record your Model Number: \_\_\_\_\_ Please record your Purchase Date: \_\_\_\_\_

**NOTE: Please keep your original sales receipt. It provides proof of the date of purchase in the event of a Guarantee claim. See Guarantee for details.**



©2016 BISSELL Homecare, Inc  
Grand Rapids, Michigan  
All rights reserved. Printed in China  
Part Number 161-1065 11/16 RevB  
Visit our website at: [www.BISSELL.com](http://www.BISSELL.com)  
Scotchgard is a trademark of 3M

Febreze is a trademark of The Procter & Gamble Company, Cincinnati, Ohio used under license by BISSELL Homecare, Inc.