



SPINWAVE™

AR دليل المستخدم

CHS 使用手册

CHT 使用指南

CZ UŽIVATELSKÁ PŘÍRUČKA

DE BENUTZERHANDBUCH

DK BRUGERVEJLEDNING

EN USER'S GUIDE

ES GUÍA DEL USUARIO

FI KÄYTTÖOPAS

FR MANUEL DE L'UTILISATEUR

HE מדרן למשתמש

HR KORISNIČKI VODIČ

HU HASZNÁLATI ÚTMUTATÓ

IT GUIDA PER L'UTENTE

JA ユーザーガイド

KO 사용 설명서

ML PANDUAN PENGGUNA

NL GEBRUIKERSHANDLEIDING

NO BRUKERVEILEDNING

PL INSTRUKCJA OBSŁUGI

PT MANUAL DE UTILIZAÇÃO

RU РУКОВОДСТВО ПОЛЬЗОВАТЕЛЯ

SE ANVÄNDARHANDBOK

SK POUŽÍVATELSKÁ PŘÍRUČKA

TA ප්‍රයෝගීන් කයෙලං

TH คู่มือผู้ใช้

TR KULLANICI KILAVUZU

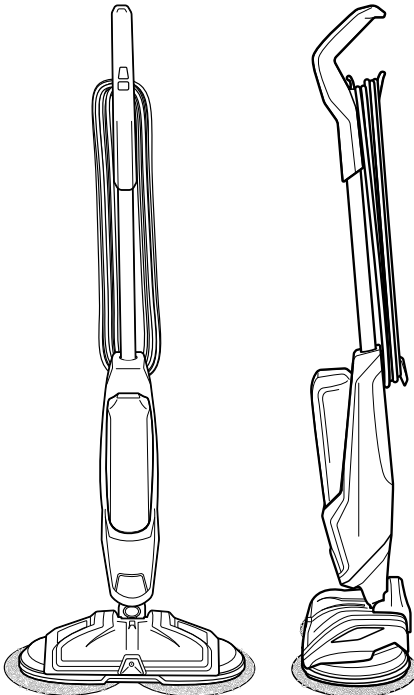

[BISSELL.com/
videos](https://www.bissell.com/videos)



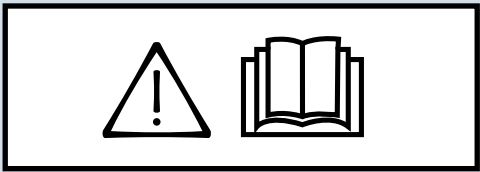

..... 3-4



..... 5-6

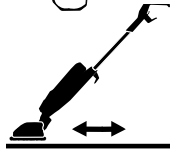

..... 7



..... 8

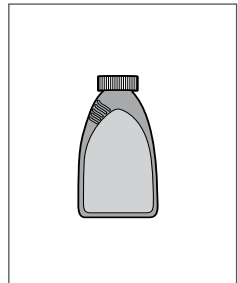
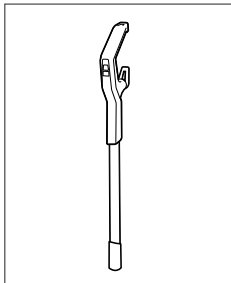
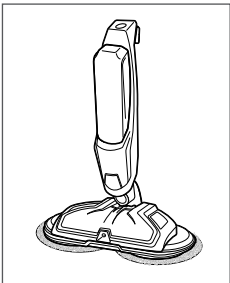

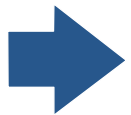
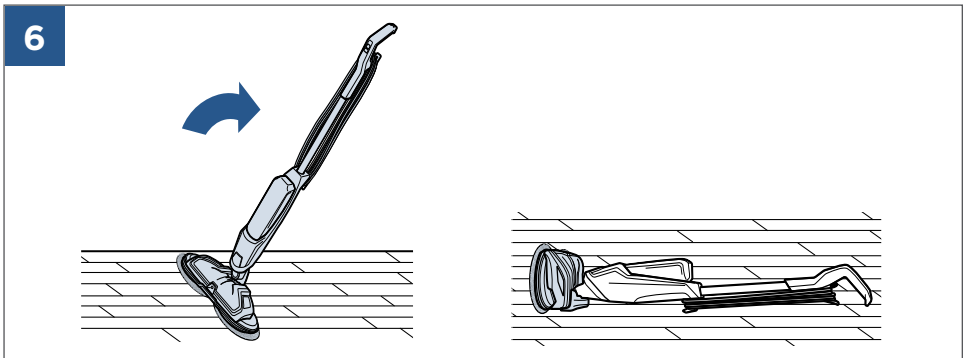
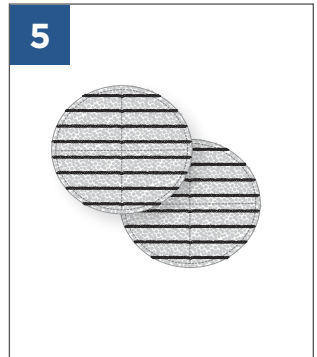
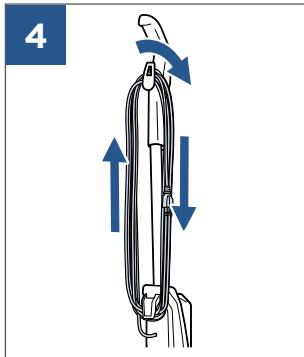
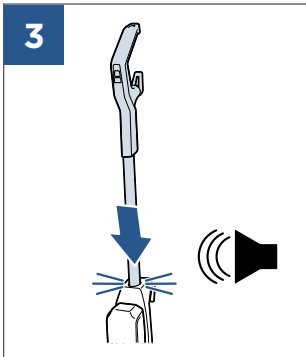
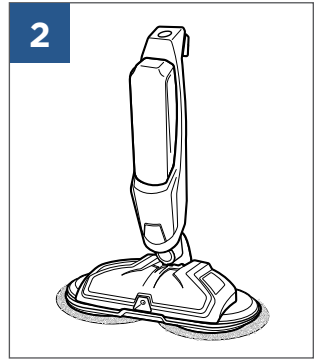
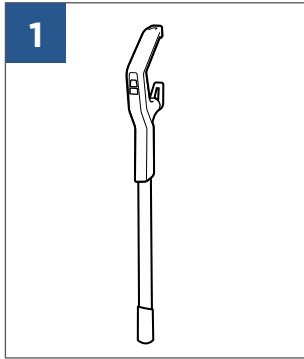
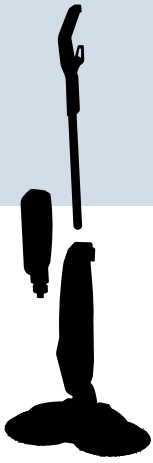

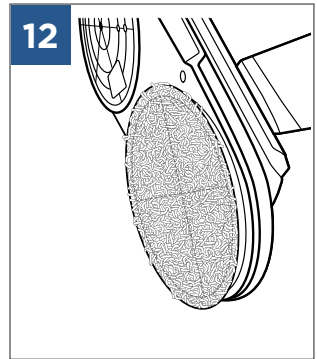
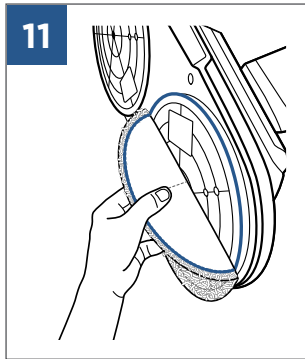
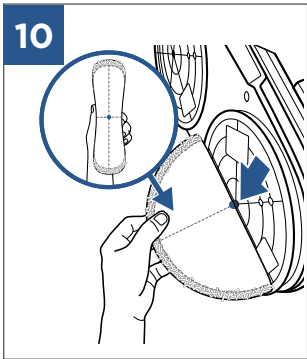
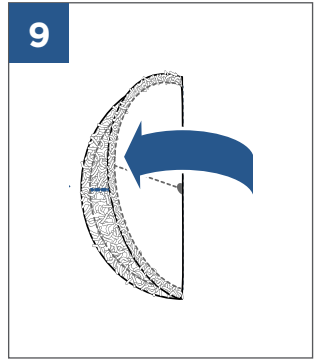
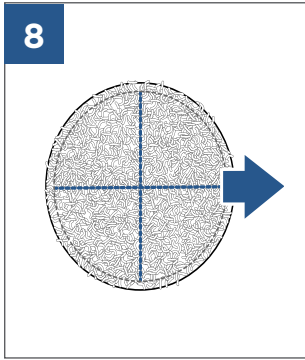
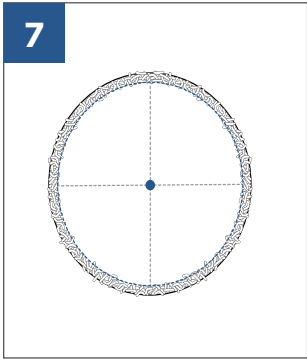

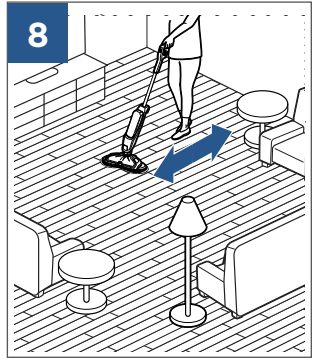
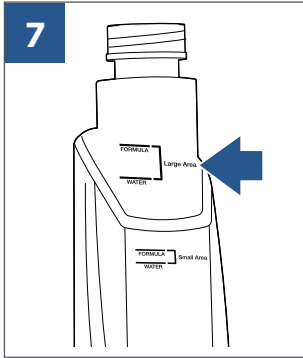
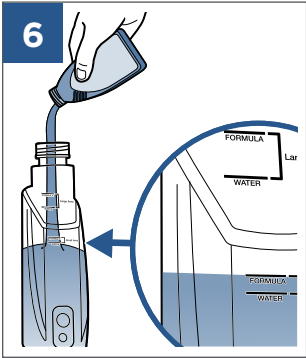
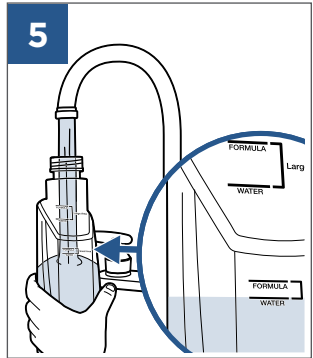
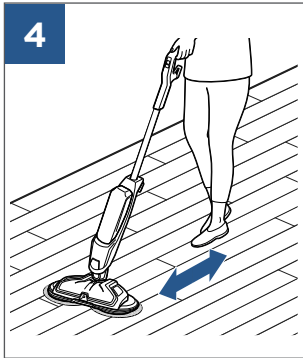
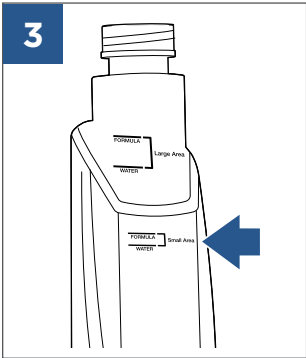
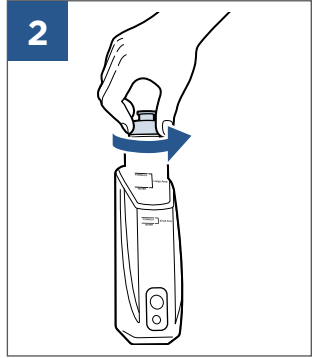
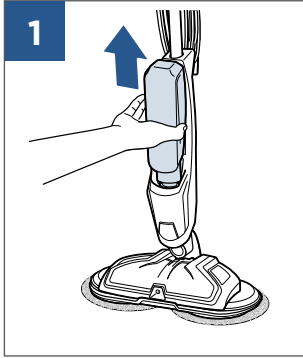
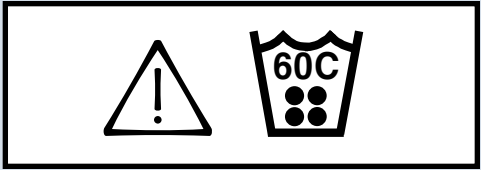
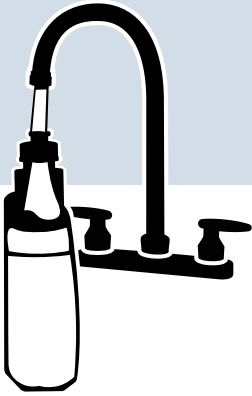

BISSELL Multi-Surface, BISSELL Wood Floor

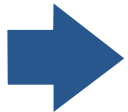

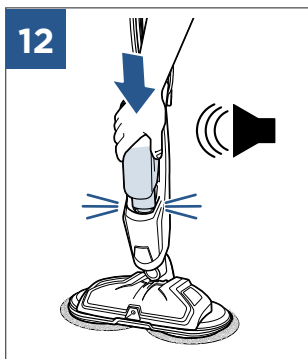
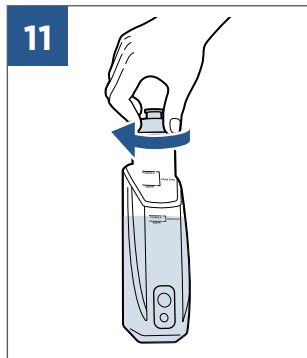
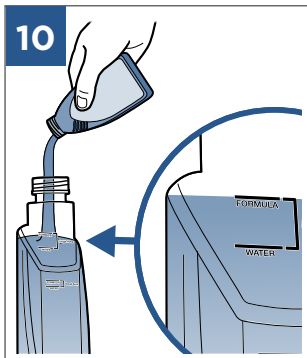
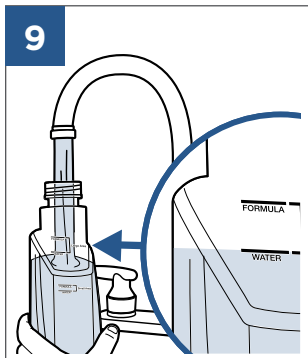
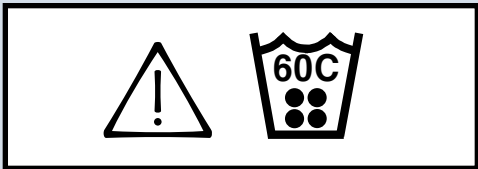

BISSELL Multi-Surface, BISSELL Wood Floor

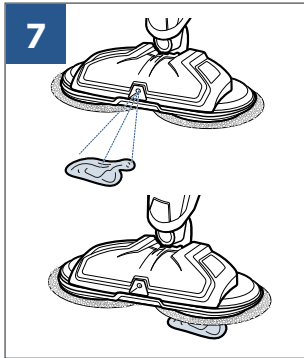
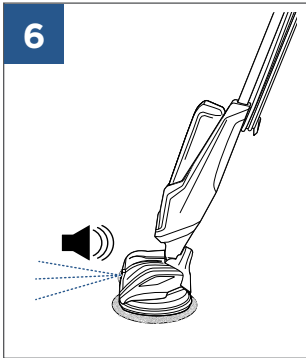
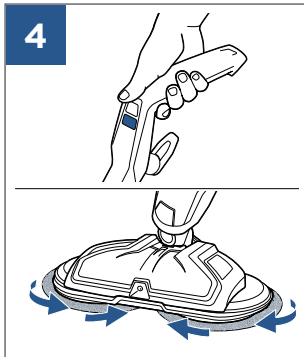
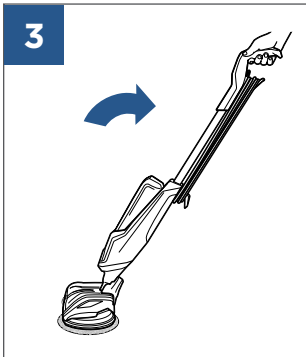
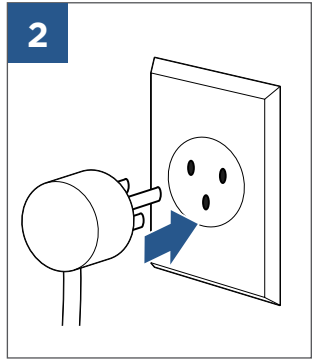
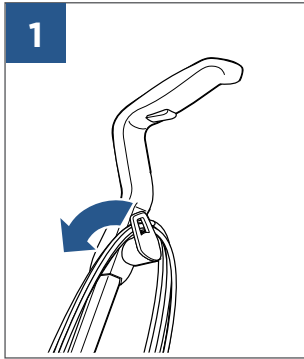
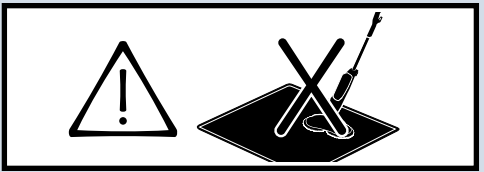
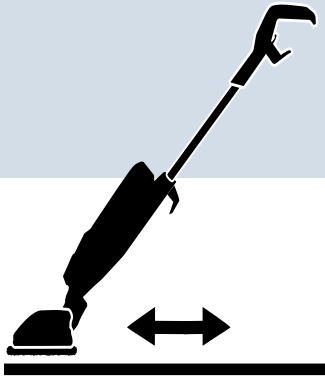

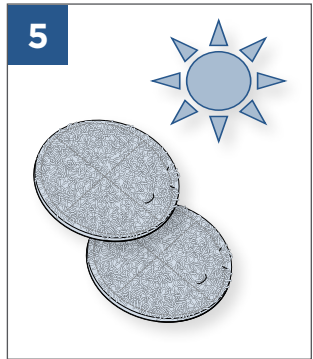
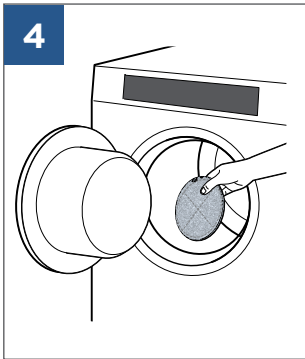
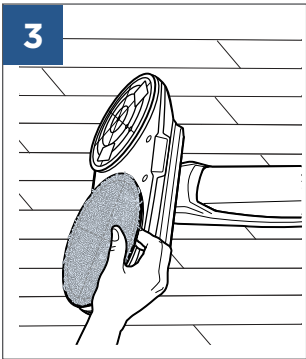
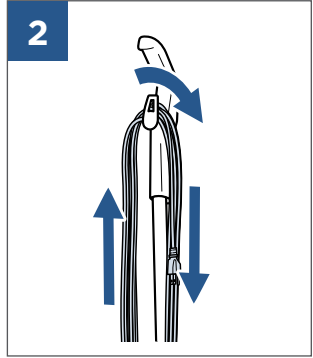
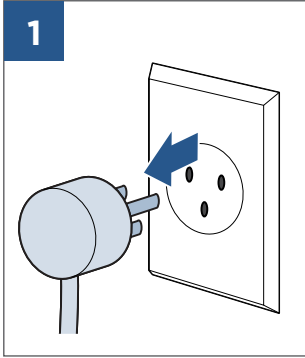
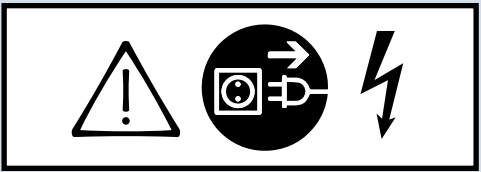
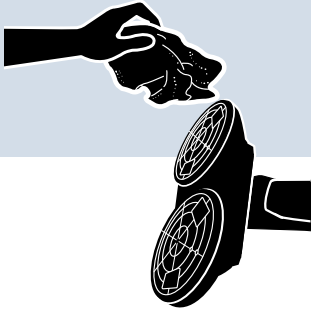

©2017 BISSELL Homecare, Inc.
Grand Rapids, Michigan
All rights reserved. Printed in China
Part Number 161-3333 11/17
Visit our website at: www.BISSELL.com